

Organizacija berbe

Sanitarni uslovi uvijek najvažniji

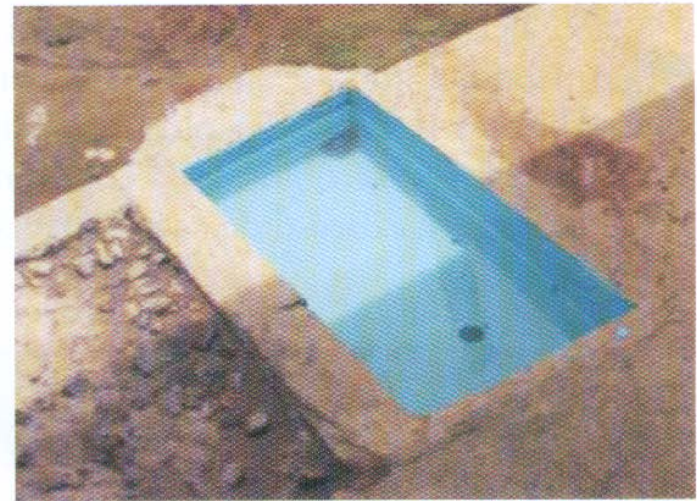
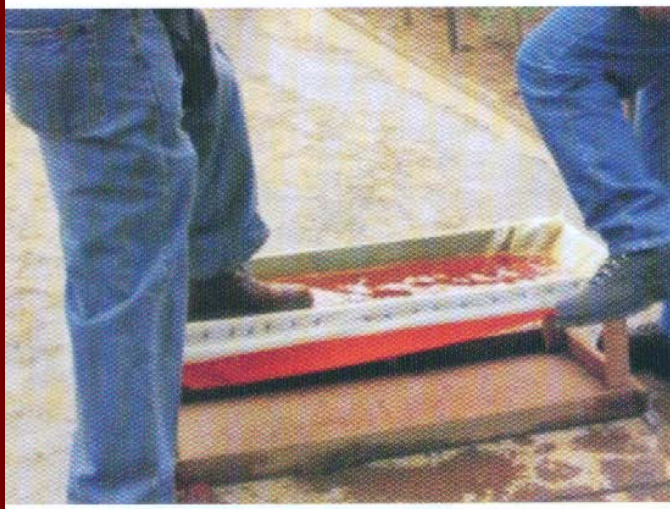

Pripreme za berbu -planiranje-

- ❑ U pripremnim radnjama obezbijediti radnu snagu, mašine, ambalažu i obuku osoblja
- ❑ Posebna pažnja se poklanja bezbjednosnim standardima



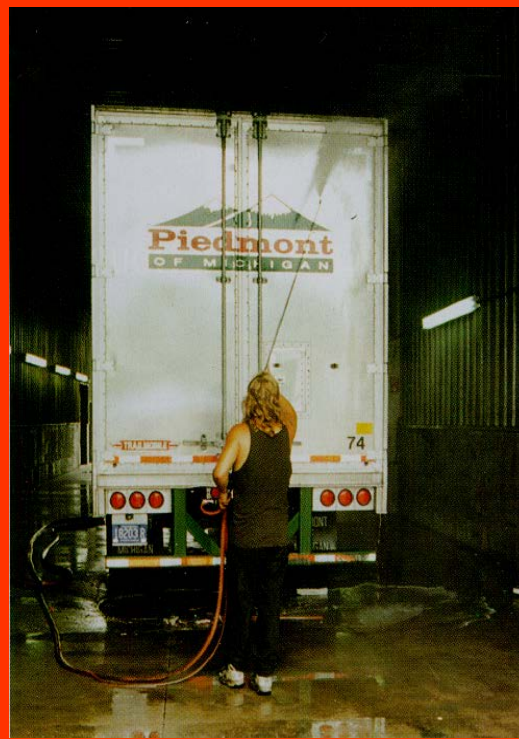

PRIPREMA AMBALAŽE



Neposredni početak berbe



Prognoza prinosa, potrebne radne snage i skladišnog prostora

Prethodna prognoza prinosa:

- utvrđivanje namjene plodova
- planira se neophodna ambalaža

Radna snaga

- predviđanje radnog učinka
- mjere stimulacije



Ambalaža i
oprema za
berbu nikada
ne smiju biti
na zemlji



Berba



- Osnovni cilj berbe voća je prikupljanje plodova iz voćnjaka u optimalnom stadijumu zrelosti uz minimalne gubitke i oštećenja
- Berbu treba obaviti što je moguće brže i uz najmanje moguće troškove
- Berba može biti:
 - mehanizovana
 - polumehanizovana
 - ručna

Mehanizovana berba

- Ima prednosti i mane
 - **Prednosti:**
 - Velika brzina rada i učinci
 - Manje radne snage i obuke
 - Manja logistika (ishrana, prevoz, smještaj, toaleti itd.)
 - Jeftinija berba
 - **Mane:**
 - Specijalizacija mašina
 - Oštećenja plodova
 - Mehanizacija je skupa
 - Sistem gajenja se mora prilagoditi karakteristikama mašine
-

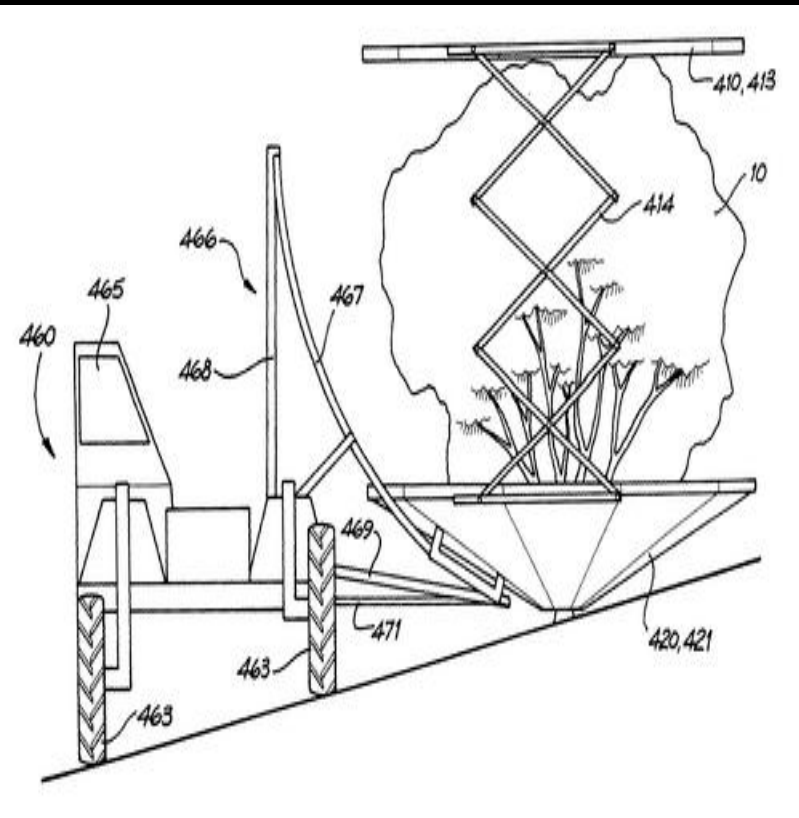

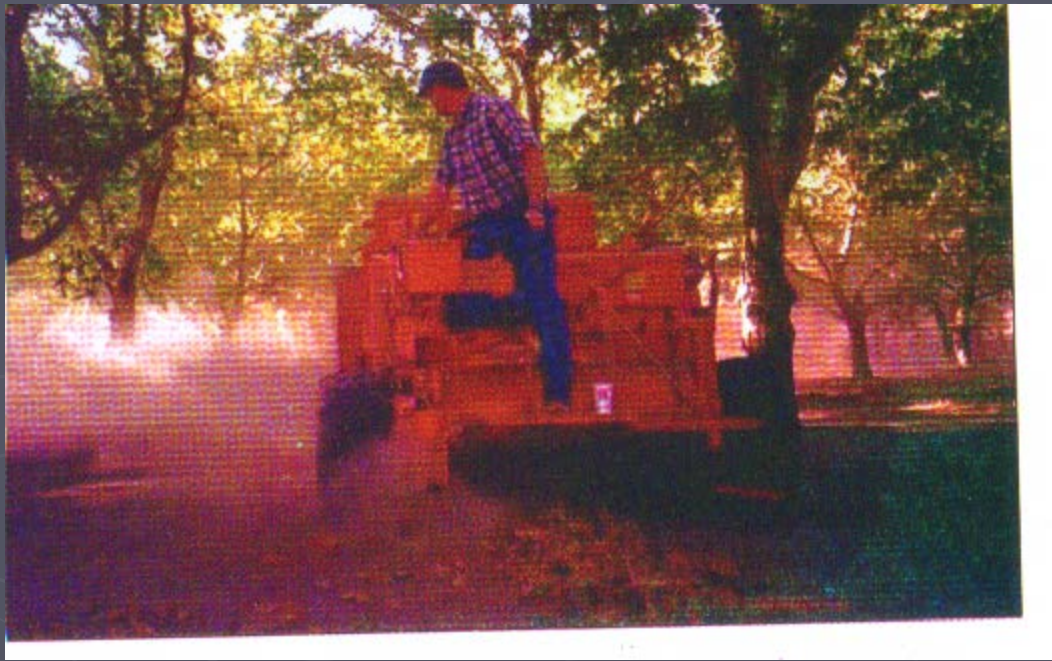





U budućnosti – roboti?

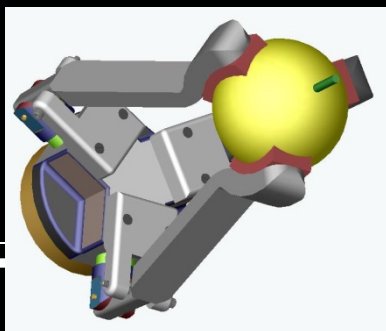

Polumehanizovana berba

- Radi se o ručnoj berbi uz uporebu određenih mehanizovanih pomagala:
 - platforme
 - pokretne trake
 - reflektori

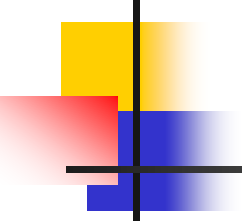
- 
- Različiti tipovi platformi i konvejera





Ručna berba

■ Prednosti:

- Berba se obavlja uz minimalna oštećenja
- Berba je precizna i selektivna
- Mogućnost prilagođavanja potrebama
- Ne oštećuju se dijelovi stabla

■ Mane:

- Nedostatak radne snage
- Logistika (ishrana, smještaj itd.)
- kontrola i stimulacija

Ovo bi trebalo zaboraviti



Probirna berba i prva selekcija



Uvijek rad učiniti lakšim





Kengur torbe



Adekvatna ambalaža

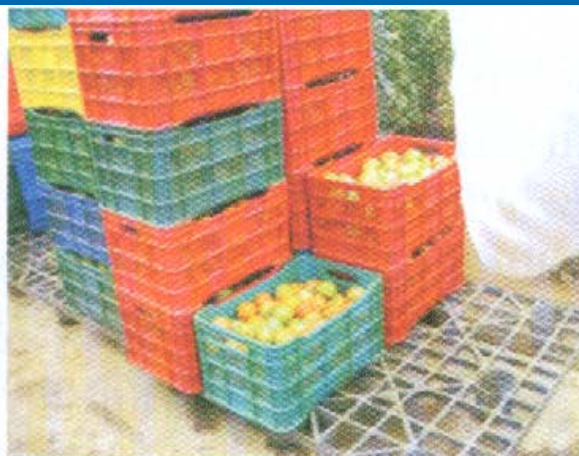
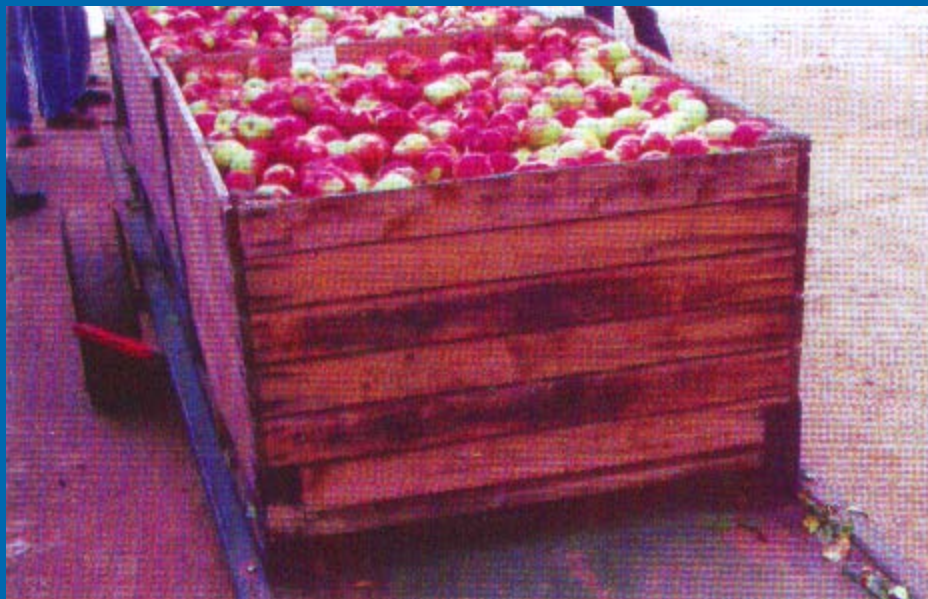

Unutrašnjost ambalaže uvijek
obložiti mekim materijalom



Transport u zasadu

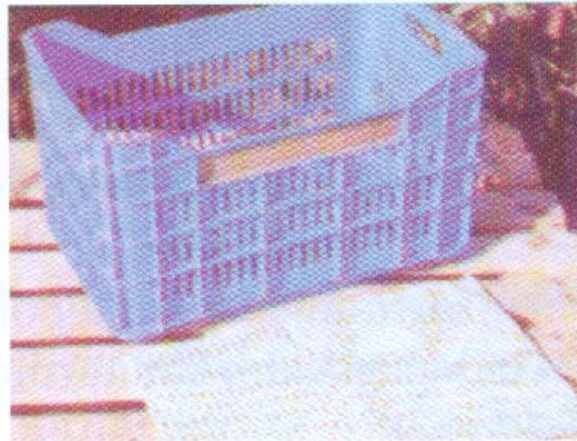

Hladiti što prije!

